



Glass Fittings

NOVAS



Contents

- Introduction
- Numbering System
- Typical Assemblies
- Glass Door Patch Fittings
- Mortise Lock Patch and Accessories
- Shower Screen Hinges and Accessories

Introduction

Novas range of Glass Fittings is designed and manufactured with innovated design concept and advanced manufacturing technology.

We are continuously developing the stainless steel glass fittings in manufacturing architectural hardware.

Product is manufactured from Grade 304 stainless steel. And Grade 316 stainless steel is also available upon request.

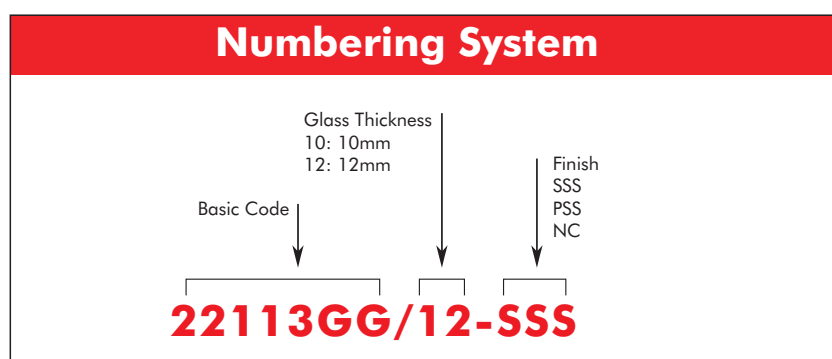

Typical Assemblies

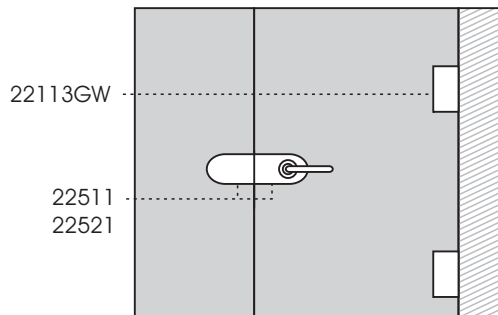
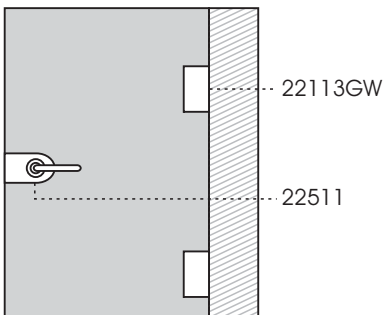
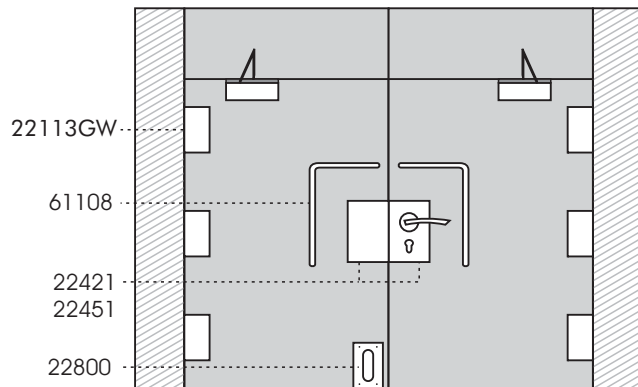
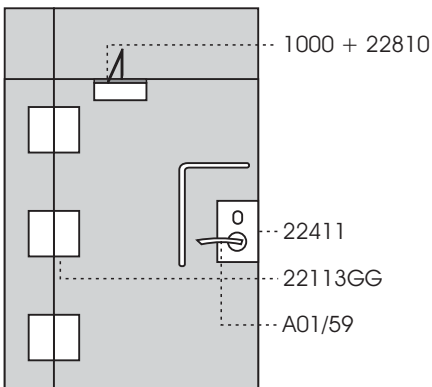
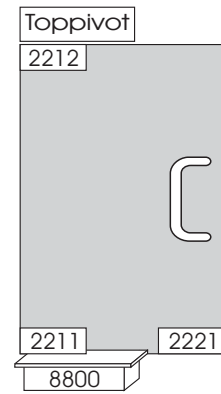
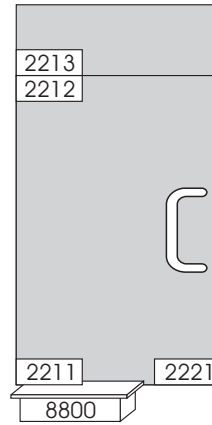
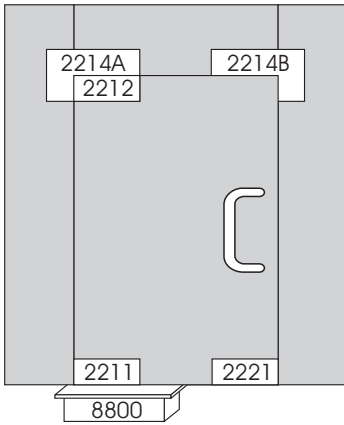

Glass Door Patch Fittings



Material: 1.5mm press-formed stainless steel cover
 Grade 316 available upon request
 Finish: SSS,PSS
 Glass Thickness: 12mm Standard

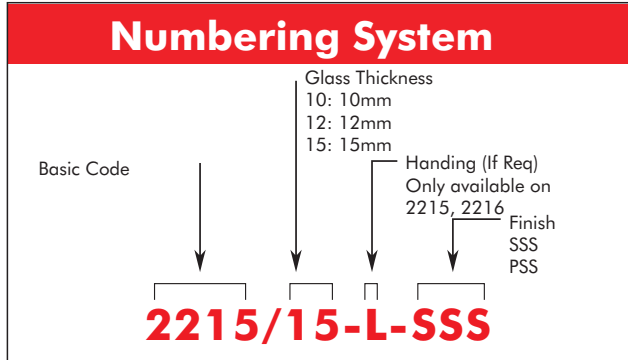

2211 Bottom Patch

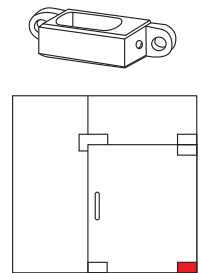
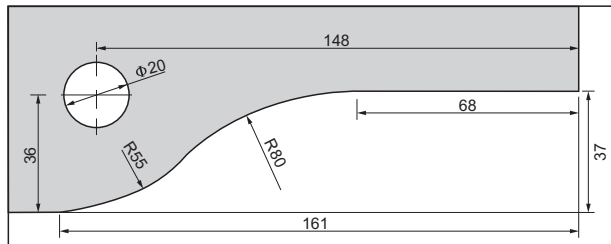
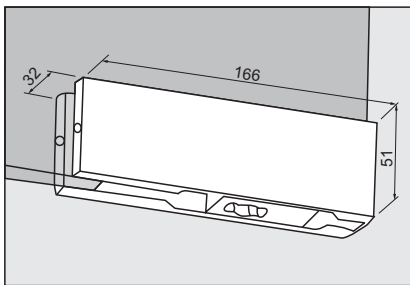

2212 Top Patch

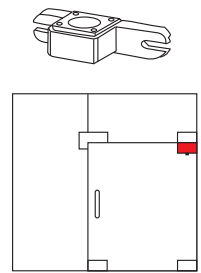
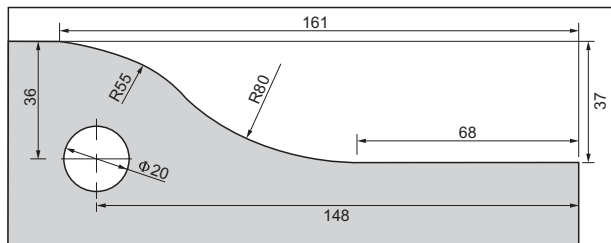
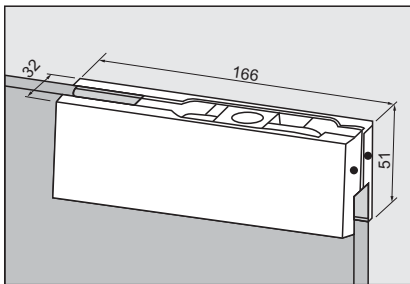

2213 Transom Patch

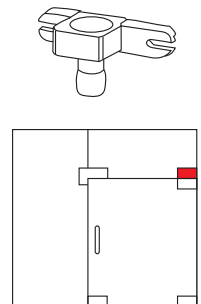
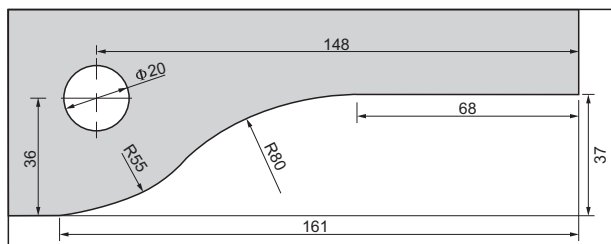
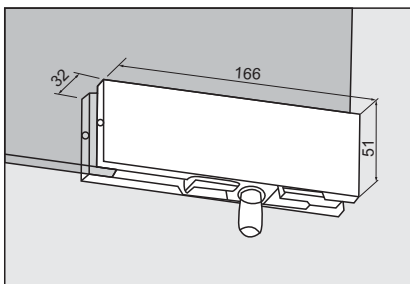

Glass Door Patch Fittings

2214 L Patch

2214A L Patch with insert A
2214B L Patch with insert B

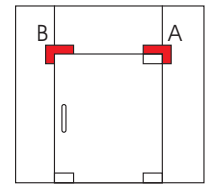
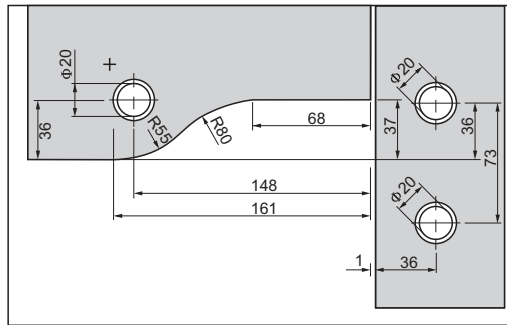
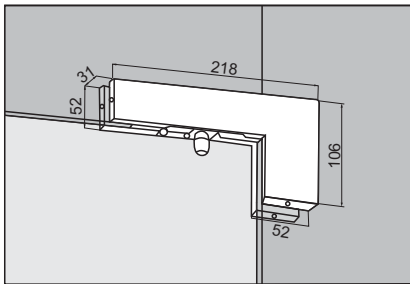

Optional Insert:

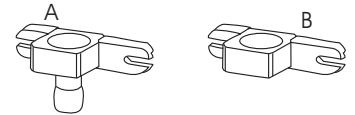

2215 T Patch

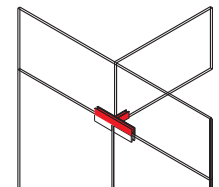
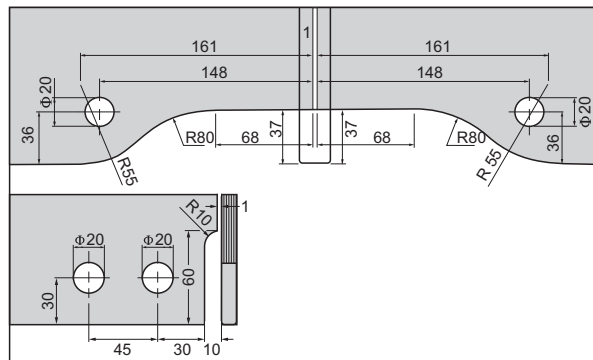
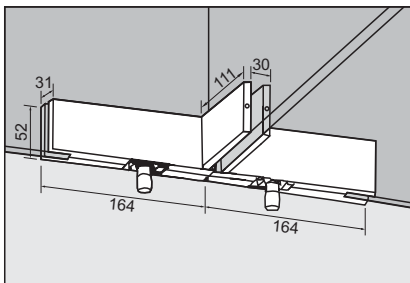

2216 F Patch

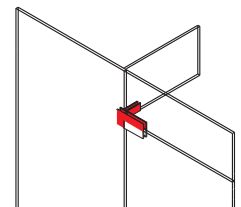
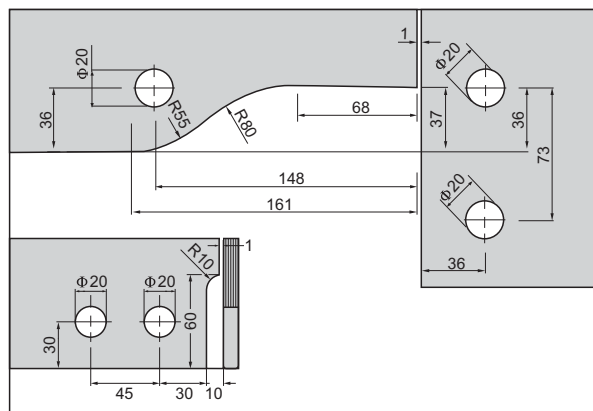
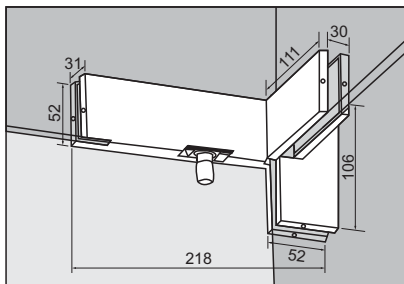

2221 Lock Patch

2221A Lock Patch A
2221B Lock Patch B

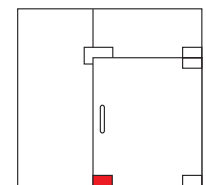
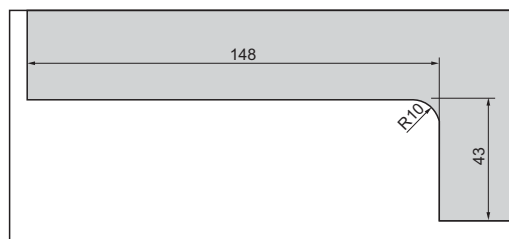
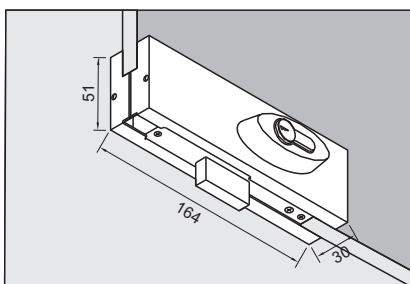

Optional Design

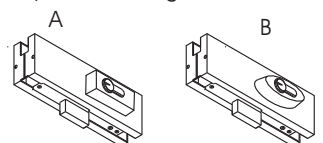

Mortise Lock Patch and Accessories

Rectangular Lock Patch



Features

- Provide an easy way to lock glass doors
- To suit oval cylinder and euro mortise locks with different selections of Novas door furniture
- Made in 304 stainless steel

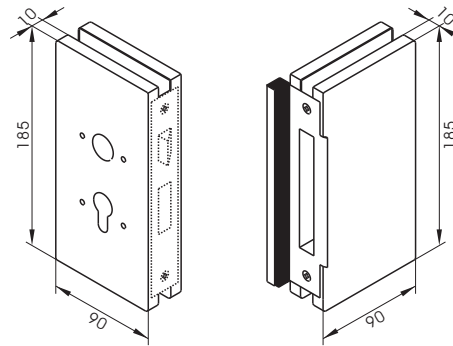

Rectangular Oval Cylinder Lock Patch

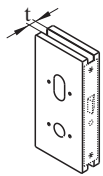

Cat No.	t Glass thickness
22411/10	10mm
22411/12	12mm
22411/15	15mm

To suit Novas 12100 Locks

Rectangular Euro Lock Patch

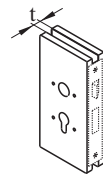

Cat No.	t Glass thickness
22421/10	10mm
22421/12	12mm
22421/15	15mm

To suit Novas 12500 Locks

Rectangular Strike Patch

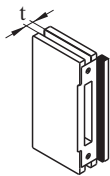

Cat No.	t Glass thickness
22451/10	10mm
22451/12	12mm
22451/15	15mm

Notes

Lock and door furniture are not included, please specify lock function when ordering.

Applications

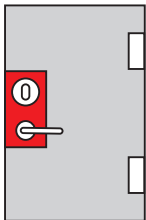

Lock patch only

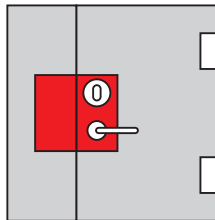

Lock and strike patch

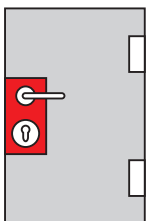

Euro lock patch only

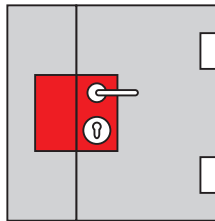

Euro lock and strike patch

Glass Cut-out

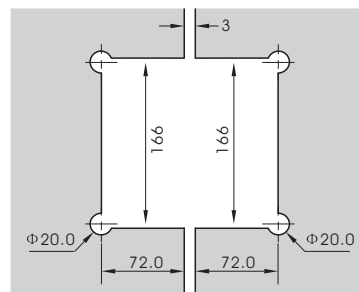

Complete Set Lock Patch Ordering Example

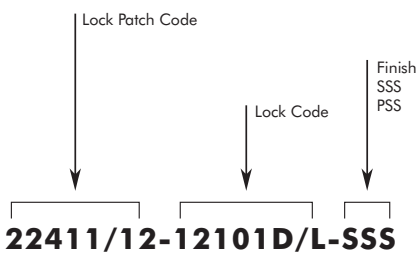

Note

Door furniture to be ordered separately from Novas door furniture catalogue.



Mortise Lock Patch and Accessories

Round End Lock Patch

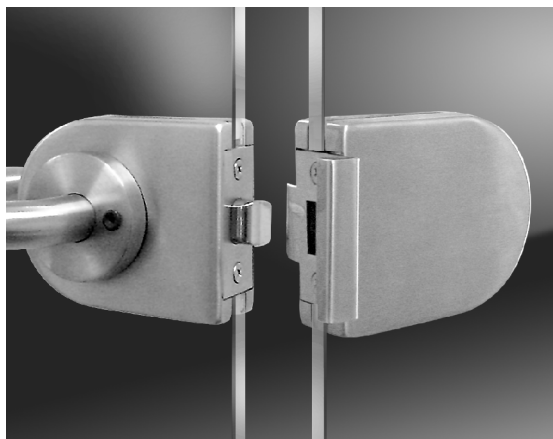

Features

- provide an easy way to lock glass doors
- modern design with multiple choice of Novas door furniture
- made in 304 stainless steel

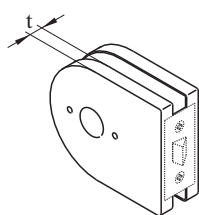
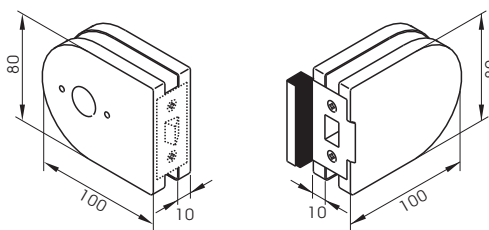

Round End Lock Patch Body

Cat No.	Finish	t Glass thickness
22511/10	SSS/PSS	10mm
22511/12	SSS/PSS	12mm
22511/15	SSS/PSS	15mm

Lock is not included

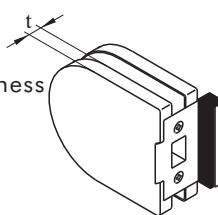

Round End Strike Patch

Cat No.	Finish	t Glass thickness
22521/10	SSS/PSS	10mm
22521/12	SSS/PSS	12mm
22521/15	SSS/PSS	15mm

Round End Lock Privacy Latch Patch

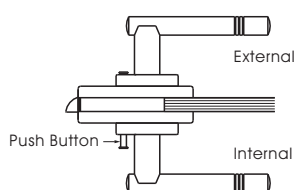
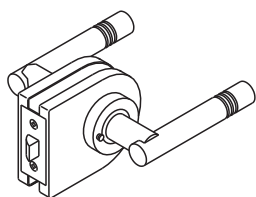

- Lockable by pushing internal push button
- Auto release by turning internal lever
- Emergence release by pushing a pin through outside releasing hole

Ordering Example

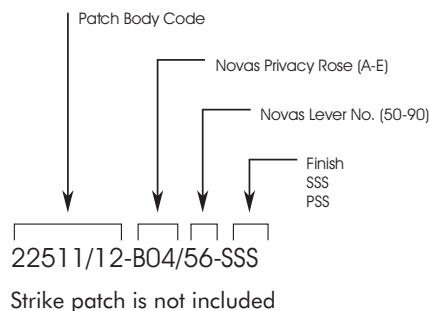

Round End Lock Patch with Key in Lever or Key in Knob

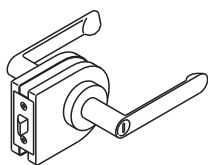

Key in Lever Patch

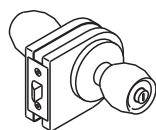

Key in Knob Patch

Select suitable key in lever or key in knob to fit Novas round end lock patch.
The lockset backset must be 60mm.

Applications

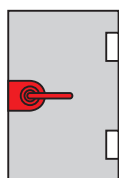

Privacy Set(Single)

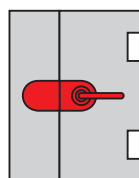

Privacy Set(Double)

Glass Cut-out

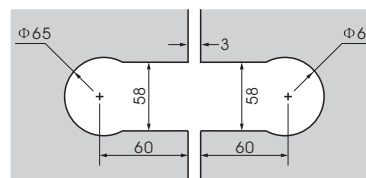

Mortise Lock Patch and Accessories

Glass Hinge



Hinge Dimensions

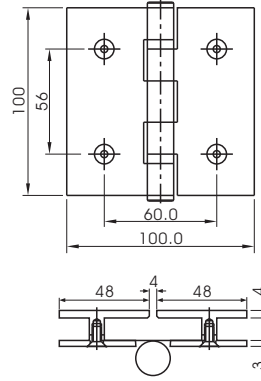

Glass Preparation

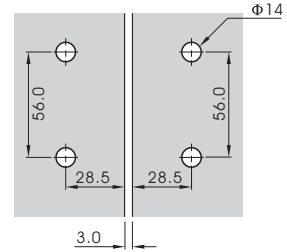

Cat No.	Finish	Glass Thickness t	Mounting
22113GG/12	SSS/PSS	10/12mm	Glass to Glass 90° /180°
22113GG/15	SSS/PSS	15mm	Glass to Glass 90° /180°
22113GW/12	SSS/PSS	10/12mm	Glass to Wall 90° /180°
22113GW/15	SSS/PSS	15mm	Glass to Wall 90° /180°

Typical Glass Hinge Installations

Glass to Wall 90°
22113GW

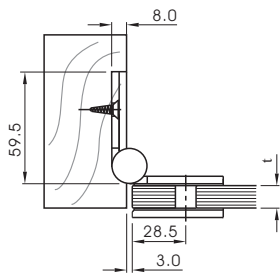

Glass to Wall 180°
22113GW

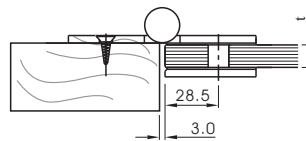

Glass to Glass 180°
22113GG

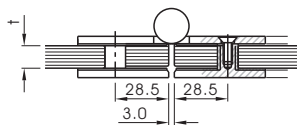

Glass to Glass 90°
22113GG

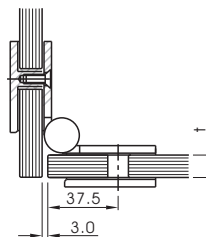

Mortise Lock Patch and Accessories

Glass Turn Bolt

Cat No.	† Glass thickness	Finish
22800/10	10mm	SSS/PSS
22800/12	12mm	SSS/PSS
22800/15	15mm	SSS/PSS

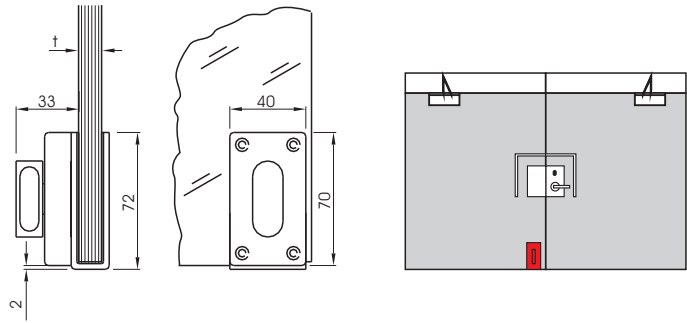

Bracket for Closer with Regular Arm

Cat No.	† Glass thickness	Finish
22810/10	10mm	SSS/PSS
22810/12	12mm	SSS/PSS
22810/15	15mm	SSS/PSS

To suit Novas 1000 door closer

For other Novas door closer, please contact local Novas representative on bracket dimension.

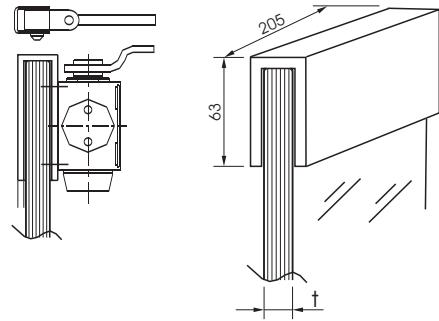

Structural Panel Link Patch

Cat No.	Finish	† Glass thickness	A	B
22964/12	SSS/PSS	12mm	164	114
22964/15	SSS/PSS	15mm	167	117

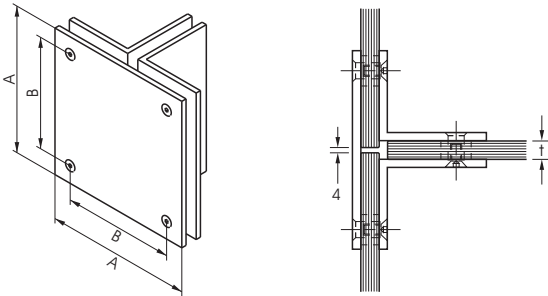

Cat No.	Finish	† Glass thickness
22973/12	SSS/PSS	12mm
22973/15	SSS/PSS	15mm

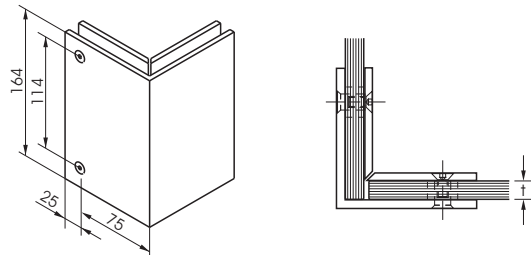

Cat No.	Finish	† Glass thickness	A	B	C
22974/12	SSS/PSS	12mm	164	114	96
22974/15	SSS/PSS	15mm	164	114	99

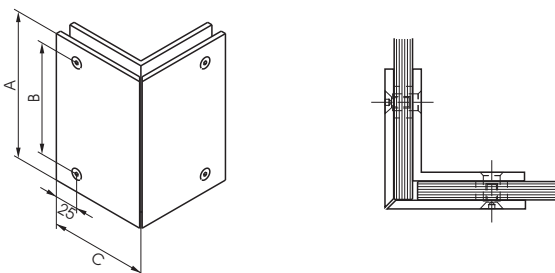

Cat No.	Finish	† Glass thickness
22978/12	SSS/PSS	12mm
22978/15	SSS/PSS	15mm

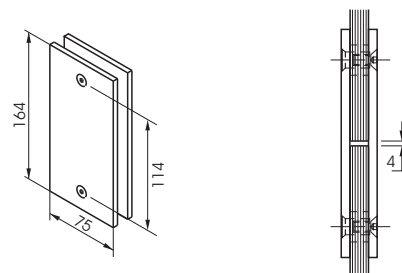

Shower Screen Hinges and Accessories

Stainless Steel Shower Screen Hinges

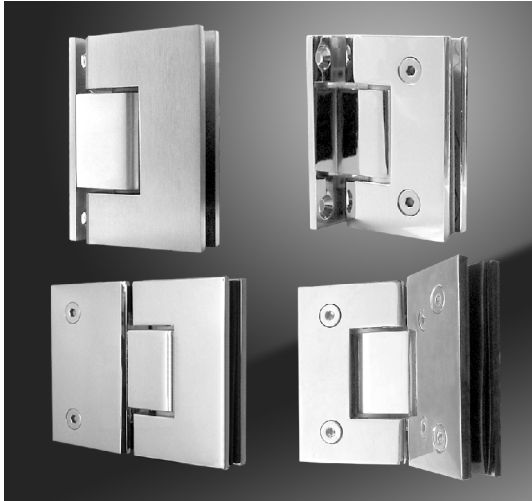

Features

- Manufactured in Grade 304 stainless steel, Grade 316 stainless steel available upon request
- Durable finish against wet climate
- Reliable and powerful spring mechanism
- Available finish: SSS, PSS and NC
- Standard glass thickness 10~12mm

180° Stainless Steel Shower Screen Hinges

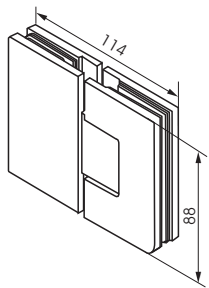

Cat No. 31180
Finish SSS/PSS/NC

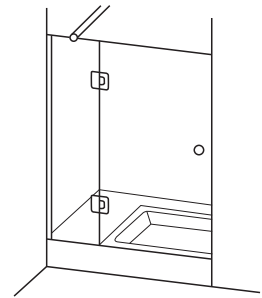
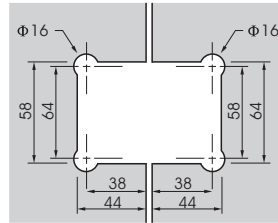
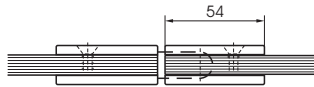

90° Stainless Steel Shower Screen Hinges

Cat No. 31090

Finish SSS/PSS/NC

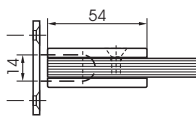
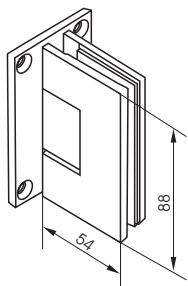

Cat No. 31190

Finish SSS/PSS/NC

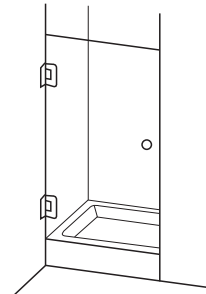
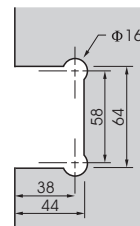
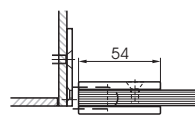
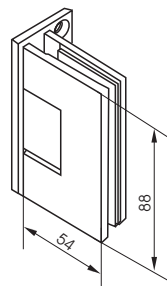

135° Stainless Steel Shower Screen Hinges

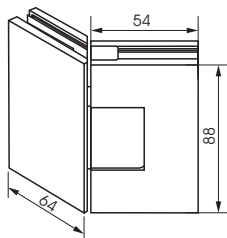

Cat No. 31135
Finish SSS/PSS/NC

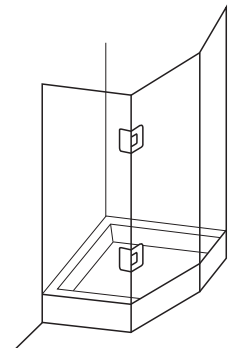
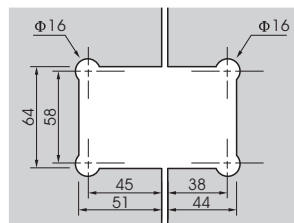
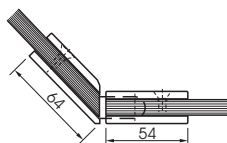

Shower Screen Hinges and Accessories

Shower Screen Pulls

31510 Series Shower Screen Pulls

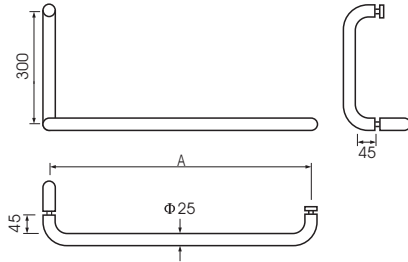

Cat No.	Finish	A(mm)
31511	SSS/PSS	450
31512	SSS/PSS	600

31520 Series Shower Screen Pulls

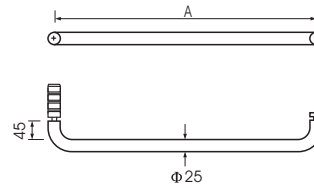

Cat No.	Finish	A(mm)
31521	SSS/PSS	450
31522	SSS/PSS	600

Shower Screen Panel Brackets

Glass to Wall 90°

Cat No.	t Glass thickness	Finish
31601/8	8mm	SSS/PSS
31601/10	10mm	SSS/PSS
31601/12	12mm	SSS/PSS

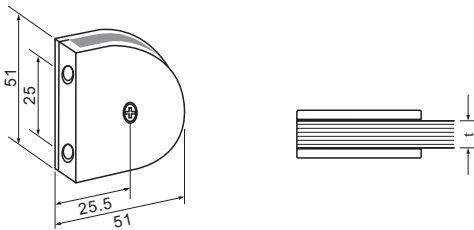

Cat No.	t Glass thickness	Finish
31602/8	8mm	SSS/PSS
31602/10	10mm	SSS/PSS
31602/12	12mm	SSS/PSS

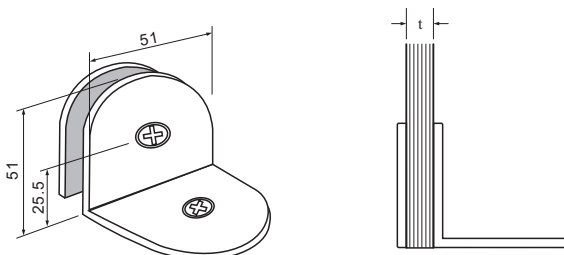

Glass to Glass 90°

Cat No.	t Glass thickness	Finish
31611/8	8mm	SSS/PSS
31611/10	10mm	SSS/PSS
31611/12	12mm	SSS/PSS

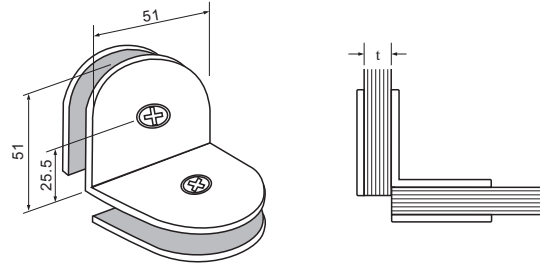

Glass to Glass 135°

Cat No.	t Glass thickness	Finish
31612/8	8mm	SSS/PSS
31612/10	10mm	SSS/PSS
31612/12	12mm	SSS/PSS

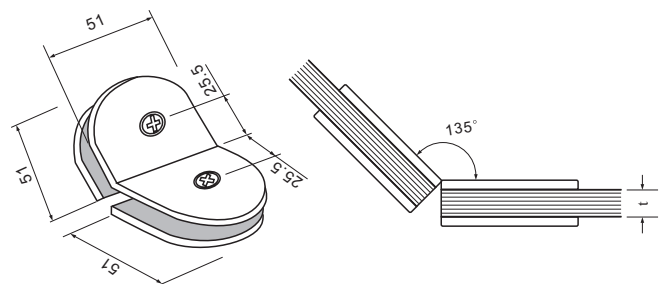



NOVAS

Guarantee

Nova Hardware guarantees all their products against defects in workmanship and materials subject to inspection and confirmation of fair wear and tear within the normal working life of the product.

Nova Hardware assumes no liability for:

1. Improper installation or failure to follow fitting instructions.
2. Product failure due to improper maintenance or unfair wear and tear.
3. Indirect or consequential loss or damage.
4. Cost of removal and/or replacement.
5. Cost of freight and/or travelling expenses.
6. Some plated finishes are classified as soft finishes. Deterioration is possible under some climatic conditions and can not be unconditionally guaranteed. Consult your local Nova representative or agent for advice on all finishes.

Finish

BRZ	Bronze	ZP	Zinc Plated
GLD	Gold	PB	Polished Brass
SIL	Silver	SB	Satin Brass
CA	Clear Anodized	PSS	Polished Stainless Steel
CP	Polished Chrome Plated	SSS	Satin Stainless Steel
PCP	Pearl Chrome Plated	NC	NOVACOTE
SC	Satin Chrome Plated		

Handing

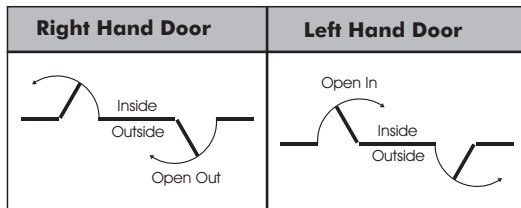

Change of Product Specifications

As a result of continuous improvements to our products, we reserve the right to alter standard product specifications and dimensions without prior notice.

Contact:

Shanghai Nova Hardware Co., Ltd.
 402/Bld 4, 1221 West Yanan Road,
 Shanghai 200050, China
 Tel: 86-21-6252 9138
 Fax: 86-21-6252 7978
 Email: sales@nova-hardware.com
 Web: www.nova-hardware.com